

# 1100

## Standard Hand Sanitizer Dispenser



1100

### GENERAL DESCRIPTION

- + Liquid hand sanitizer dispenser 1 Lt capacity, is made with stainless steel 304 S.S 0.70 mm thickness.
- + Push handle made with stainless steel 304.
- + Available only in satine finish
- + Useful for the public areas
- + It is recommended use only for soap and hand sanitizing liquids.
- + It doesnt support that contains chlorine or solid abrasive particles.
- + It is mounted with three steel 4 mm screws (provided in the box) with their 8 mm plastic plugs (also provided).
- + Inner plastic tank is made with polyethylene. The tap on the tank helps to refill easily .

### COMPONENTS AND MATERIAL

- + 1100 Stainless steel 304 satine finish

### INSTALLATION

- + First measure out where the liquid dispenser will be placed, mark three holes and drill into the wall.
- + Insert the provided wall plugs and screw in the top two screws, leaving a slight gap for the dispenser to slot onto.
- + Remove the liquid container before mounting the dispenser to the wall.
- + Slot the dispenser onto the two previously fixed screws and then screw final screw.
- + Once the dispenser is secure, insert the liquid container back into the dispenser.

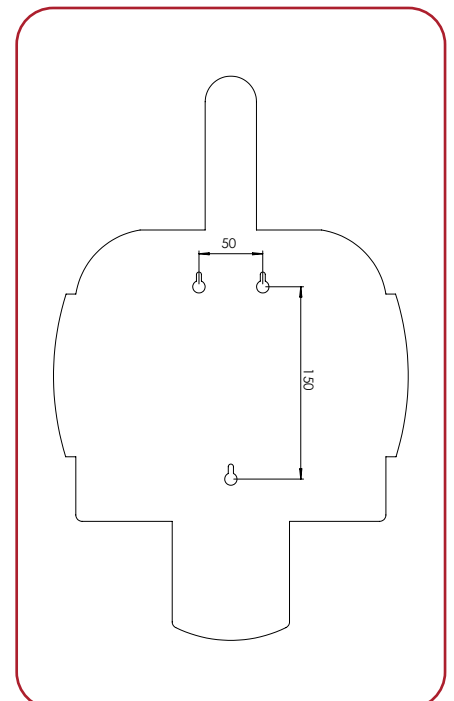
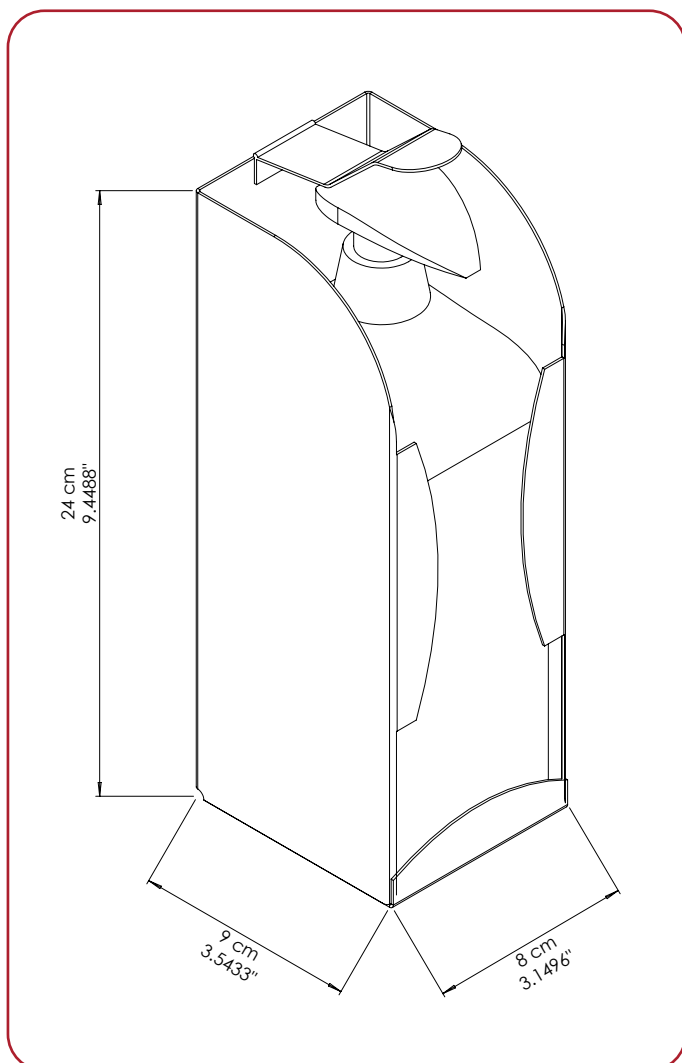

### FILLING THE TANK

Unscrew the cap at the top and fill the tank avoiding spilling outside. Replace the cap and close the cover.

### MOUNTING TEMPLATE









Should be minimum 100 cm high from the floor.

### DISPENSER REPLACEMENT REQUIREMENTS AND RECOMMENDATIONS

The following recommendations are intended to provide guidelines on the best possible placement of the dispensers. Because every location a dispenser is to be mounted is different, depending on customer site, physical size limitations, and available space, these recommendations may not always be entirely possible to follow. However, when placing a dispenser installation must meet ADA requirements and should promote ease of use and be in union with its surroundings. Upon installation, the dispenser should be level and the job results professional, presentable and fully functional.

### AFTERCARE INSTRUCTIONS

- + Regular cleaning with a soft cloth will keep the surface of your product looking new. Soapy water can be used to remove stubborn marks. Don't use abrasive or chemical cleaners as these may damage the surface finish over time.
- + Don't expose to sunlight.
- + Don't respond to the product with force against the possibility of damnification, deformation.
- + Don't throw any cigarettes and flammable materials into the product.

								
PRODUCT CODE	LITER	PRODUCT DIMEN.	CARTON DIMEN.	CARTON WEIGHT	INBOX QUANTITY	PALLET QUANTITY	GROSS PALLET DIMEN.	GROSS PALLET WEIGHT
1099	1 L	9x8x24 cm	30x40x50	18,00 kg	24	768	80x120x215 cm	590 kg