

DM0912S

Touchless Toilet Waste Unit



DM0912S

GENERAL DESCRIPTION

- + 19-21 cm roll towel
- + Toilet waste unit is made with 304 stainless steel 0.80 mm.
- + Operates with 4 batteries (D).
- + Electricity with 220V socket.
- + Stainless steel key.
- + Adjustable sheet length.
- + Easy to assemble.
- + Security lock system.
- + Counter wall option.
- + 23 lt bin capacity with lock.

COMPONENTS AND MATERIAL

- + DM0912S- Stainless Steel 304 satine finish

INSTALLATION

- + First measure out where the touchless dispenser will be placed, mark six holes and drill into the wall.
- + Insert the provided wall plugs and screw in the top two screws, leaving a slight gap for the dispenser to slot onto.
- + Slot the dispenser onto the two previously fixed screws and then screw final screws.
- + Once the dispenser is secure, insert the paper back into the dispenser by using the adjustable handles inside.

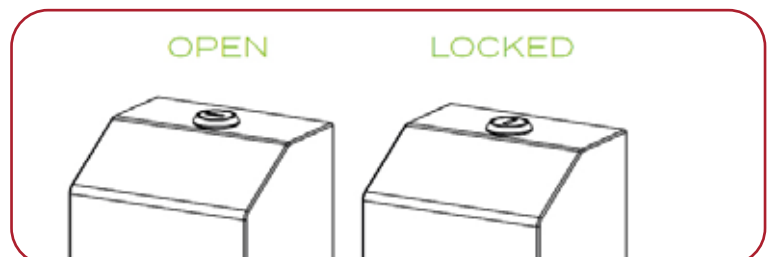
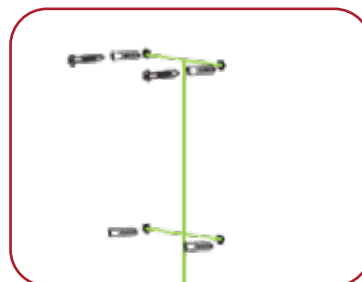
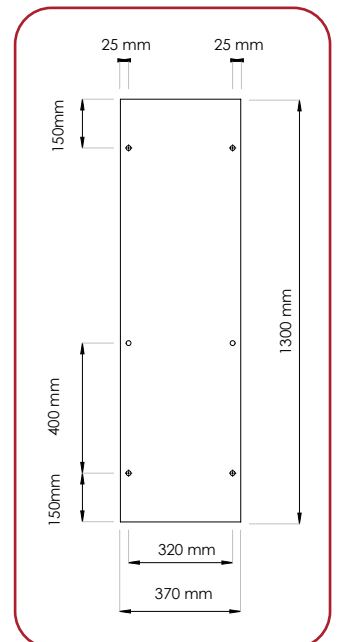
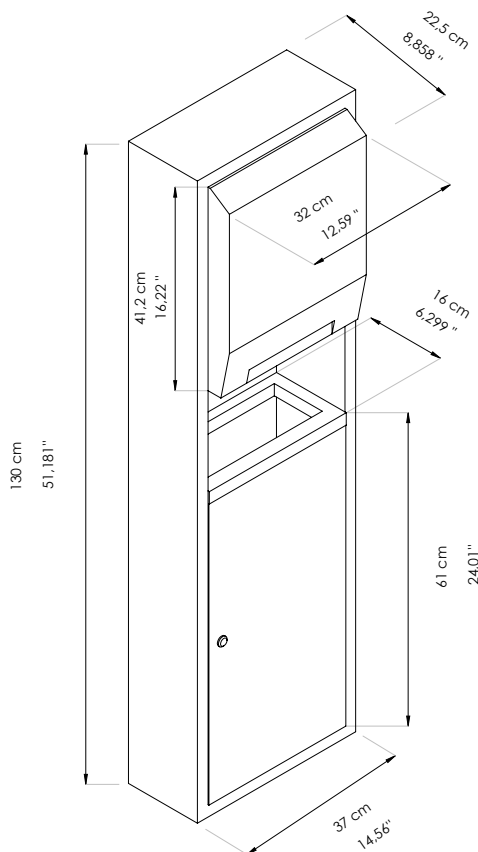

INSERTING THE BATERIES

1. Open the battery compartment by removing the cover.
2. Insert 13A/1.50V alkaline batteries paying attention to the polarity. Alkaline batteries are highly recommended. Put the cover back on the battery compartment b pushing until "click"
3. Close the front cover of the dispenser.

ATTENTION

The dispenser cover must be closed to work properly. When the supply voltage is too low, Led will blink continously and then the dispenser will not work. Please change the batteries immediatly.

MOUNTING TEMPLATE









Should be minimum 120 cm high from the floor.

DISPENSER REPLACEMENT REQUIREMENTS AND RECOMMENDATIONS

The following recommendations are intended to provide guidelines on the best possible placement of the dispensers. Because every location a dispenser is to be mounted is different, depending on customer site, physical size limitations, and available space, these recommendations may not always be entirely possible to follow. However, when placing a dispenser installation must meet ADA requirements and should promote ease of use and be in union with its surroundings. Upon installation, the dispenser should be level and the job results professional, presentable and fully functional.

AFTERCARE INSTRUCTIONS

- + Regular cleaning with a soft cloth will keep the surface of your product looking new. Soapy water can be used to remove stubborn mark. Dont use abrasive or chemical cleaners as these may damage the surface finish over time.
- + Don't expose to sunlight.
- + Don't respond to the product with force against the possibility of damnification, deformation.
- + Don't throw any cigarettes and flammable materials into the product.

								
PRODUCT CODE	LITER	PRODUCT DIMEN.	CARTON DIMEN.	CARTON WEIGHT	INBOX QUANTITY	PALLET QUANTITY	GROSS PALLET DIMEN.	GROSS PALLET WEIGHT
DM0912S	30 L	130x31x16 cm	137x44x30 cm	16,7 kg	1	8	80x120x160 cm	150 kg